



PRODUCT SPECIFICATION GUIDE

2022



Low Maintenance and Barefoot Friendly

- EZ Dock polyethylene docks are durable and slip resistant
- Won't splinter or rot, never needs painting
- Cleans easily with soap and water



Adaptable Design

- Unique design delivers outstanding load capacity, functionality, and safety
- Variety of dock sections, boat/PWC lifts, and launches for kayaks
- Easily customizable design to make your perfect waterfront retreat



Flexible Flotation Technology

- Flotation chambers constructed for optimal strength and structural integrity
- Designed to provide additional stability on the water
- Dock sections adapt easily to changing water conditions and levels



Innovative Coupling

- Made of recycled materials
- Nuts and bolts made of heavy duty, rust resistant composite
- Strength and durability even in the harshest weather conditions



American Made

- Proudly for 30 years

DOCK SECTIONS

They have the best features built right in.

These sections are molded to be durable, slip-resistant, and low-maintenance. Slip-resistant texture is molded right into the top, so these docks are safer than wood or concrete for bare feet. The materials are made to last, with no need for repainting or maintenance for rot and splintering.

They create customizable dock systems.

Our dock sections come in multiple shapes and sizes, so they can be configured to your exact specifications. The range of choices means you get the design you need for your commercial or residential dock.

They are more durable.

Traditional floating docks are one section, which can make them stiff and unyielding in harsh weather, increasing the risk of damage. In bad weather, EZ Dock sections move independently, making your system stronger and more resistant to damage. This bit of give has allowed EZ Dock systems to withstand even tropical storms.

They are easy to install.

All you need to do is join each section with the innovative couplings and tighten the bolts. Your dock will be up and running in no time, providing a perfect spot for boating, fishing, and swimming.

Part #	Model	Color	Size	Weight	Floataion
A	204060 204060-EZGR	Beige ●	39" X 58-1/2" X 14-5/8"	167 lbs.	2000 lbs.
		Grey ●			
B	204010 204010-EZGR	Beige ●	39" X 117" X 14-5/8"	95 lbs.	1000 lbs.
		Grey ●			
C	206010 206010-EZGR	Beige ●	58-1/2" X 117" X 14-5/8"	257 lbs.	3000 lbs.
		Grey ●			
D	208010 208010-EZGR	Beige ●	78" X 117" X 14-5/8"	295 lbs.	4000 lbs.
		Grey ●			
E	208008 208008-EZGR	Beige ●	98" X 78" X 14-5/8"	339 lbs.	3100 lbs.
		Grey ●			
F	158010 158010-EZGR	Beige ●	78" X 117" X 7-5/8"	250 lbs.	1900 lbs.
		Grey ●			
G	260120 260120-EZGR	Beige ●	58-1/2" X 59" X 117" X 14-5/8"	189 lbs.	2000 lbs.
		Grey ●			
H	300503 300503-EZGR	Beige ●	58-1/8" X 58-1/8" X 80-13/16" X 14-5/8"	70 lbs.	750 lbs.
		Grey ●			
I	301100	Black ●		7 lbs.	

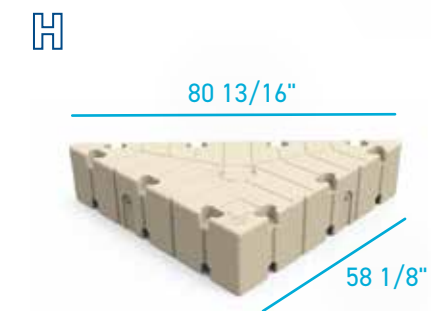
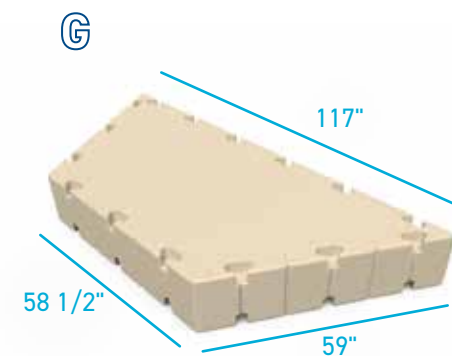
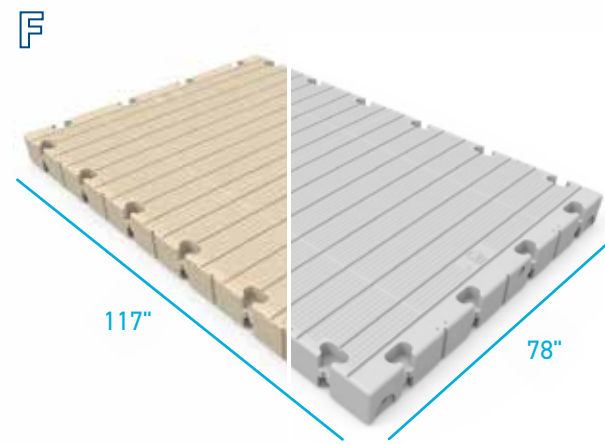
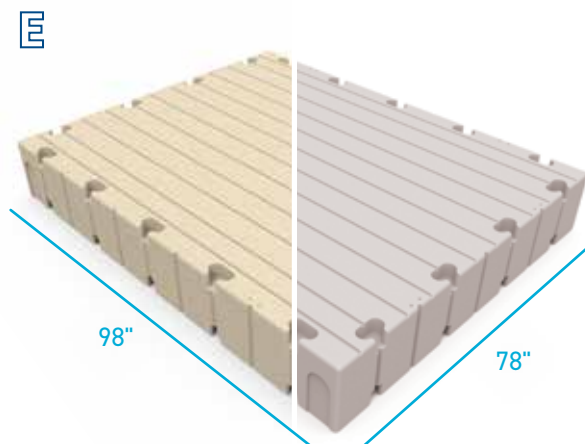
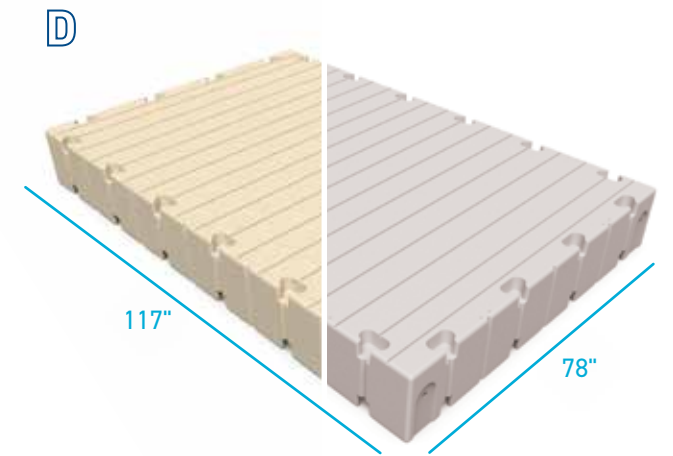
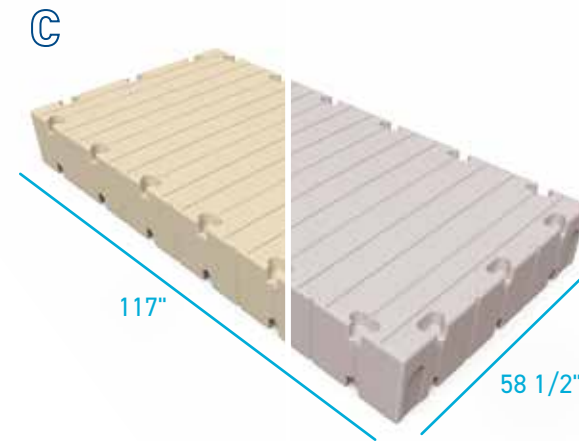
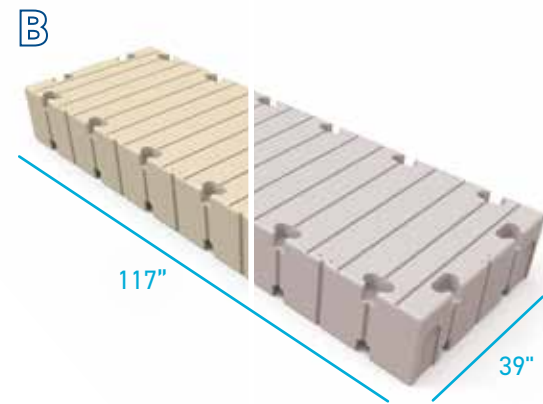
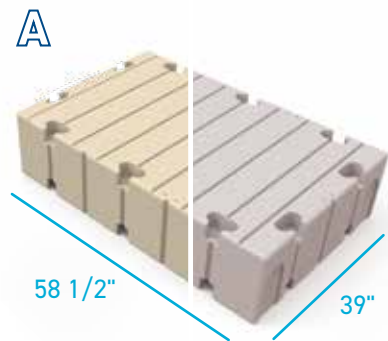

PERSONAL WATER CRAFT PORTS

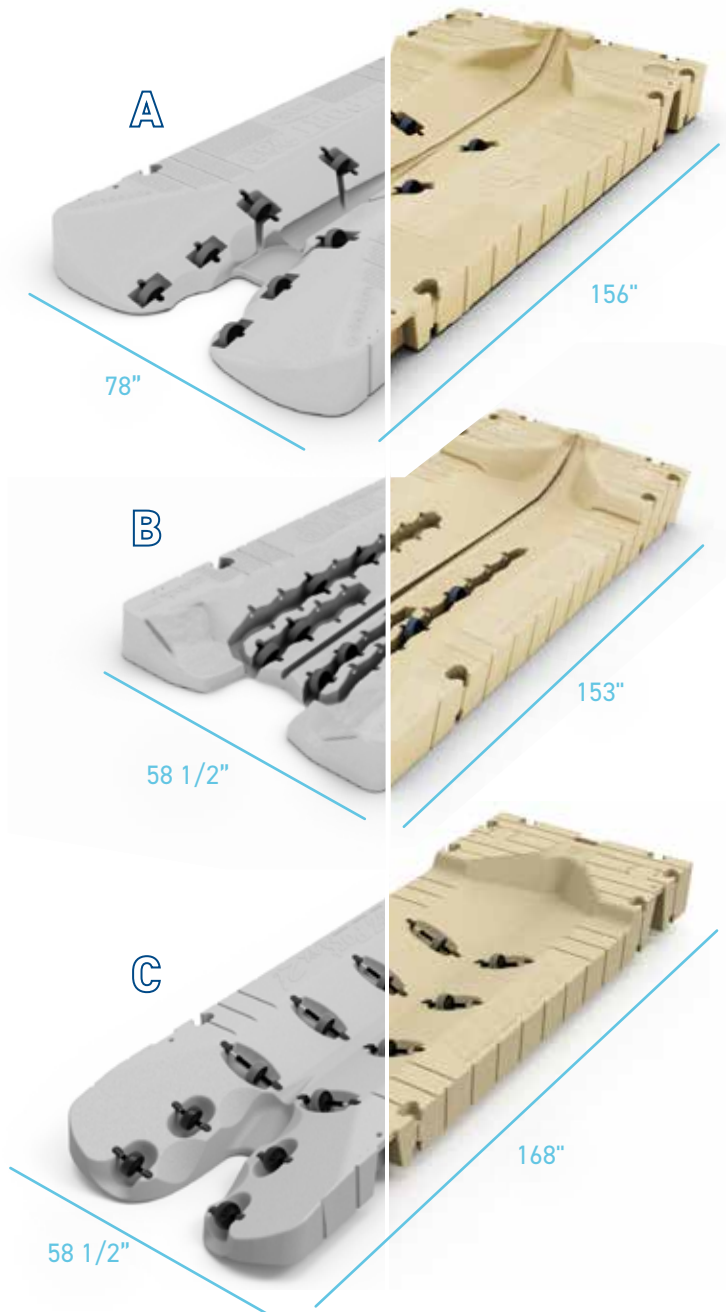

Ease of use and access
EZ Ports feature a raised bow that helps prevent overshooting the port, with no winching, cranking, pumping, or hoisting needed.

Flexibility
All EZ Ports can be linked together and easily adapted to other floating and fixed docks using our revolutionary EZ Port® coupler system with EZ Dock connectors.

Stability
Our proprietary flotation chamber and pylon design provides enhanced buoyancy and stability to reduce movement even in rough water and stormy conditions. EZ Port also provides plenty of space on the front and either side of the port to allow PWC users to find their footing comfortably.

Protection
EZ Port PWC lifts move with changing water levels, protecting personal watercraft from waves, wind, and the damage they can cause. Our personal watercraft ports are also covered by an industry-leading 8-year warranty.

Low maintenance and barefoot friendly
EZ Dock's polyethylene ports are durable and slip resistant. They won't splinter or rot and never need painting. They are easy to clean with a pressure washer or EPA-approved cleaning solutions.

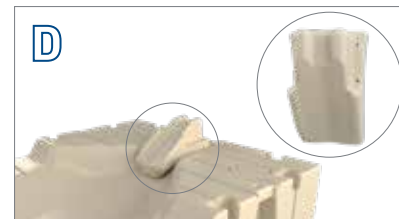

	Part #	Model	Color	Size	Weight
A	208013PW	EZ Port 280	Beige ●	156" x 78" x 14-5/8"	330 lbs.
	208013PW-EZGR		Grey ●		
B	206037PW	EZ Port VXP	Beige ●	153" x 58-1/2" x 14-5/8"	325 lbs.
	206037PW-EZGR		Grey ●		
C	206036PW	EZ Port 2i	Beige ●	168" x 58-1/2" x 14-5/8"	350 lbs.
	206036PW-EZGR		Grey ●		
D	206028BS-EZ	Bow Stop Kit, 2i	Beige ●		
	206028BS-EZGR		Grey ●		

Floating Drive-On-Watercraft Dock | US Pat. 7069872 | CAN Pat. 2555270

EZ PORT MAX INLINE

The modular, adjustable, and expandable EZ Port MAX PWC port system is built to accommodate multiple PWC's of different shapes. The EZ Port MAX is one of the most flexible options available and can be customized to maximize slip spaces with tandem inlines that help you accommodate more PWC's per slip. Just configure the design that best suits your waterfront and adjust the design any time your needs change.

The EZ Port MAX is a flexible system designed for single, multiple, or inline ports to accommodate multiple PWC's.

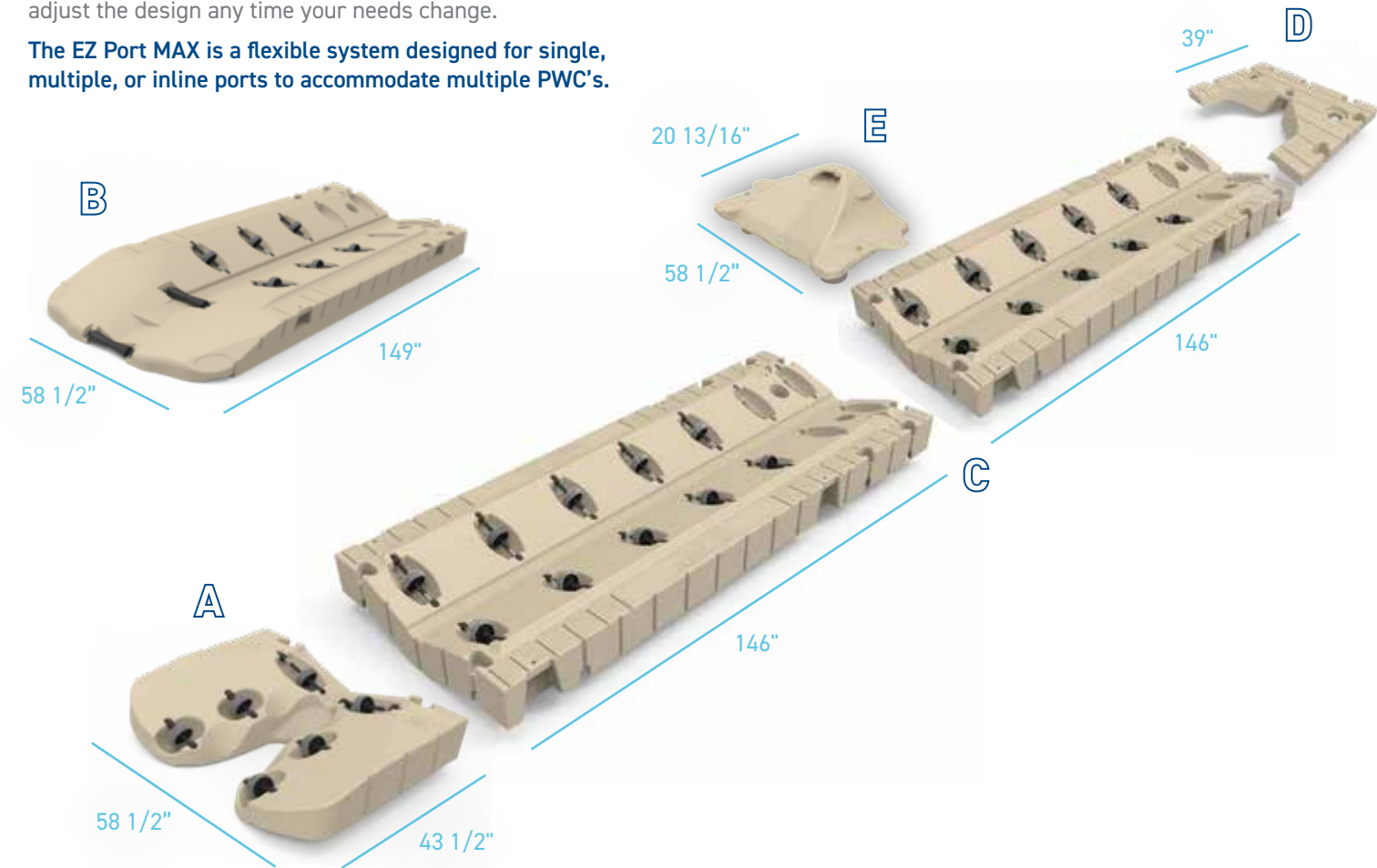

	Part #	Model	Color	Size	Weight
A	206033EX	EZ Port MAX Easy-Lift Entry	Beige ●	43-1/2" x 58-1/2" x 10-7/16"	95 lbs.
	206033EX-EZGR		Grey ●		
B	206030PW	EZ Port MAX Entry	Beige ●	149" x 58-1/2" x 10-7/16"	266 lbs.
	206030PW-EZGR		Grey ●		
C	203031PW	EZ Port MAX Extension	Beige ●	146" x 58-1/2" x 10-7/16"	266 lbs.
	203031PW-EZGR		Grey ●		
D	206025BS	EZ Port MAX Full Deck Bow	Beige ●	39" x 58-1/2" x 10-1/2"	65 lbs.
	206025BS-EZGR		Grey ●		
E	206027BS	EZ Port MAX Small Bow	Beige ●	38-1/2" x 20-13/16" x 15"	16 lbs.
	206027BS-EZGR		Grey ●		

Modular Floating Watercraft Port Assembly | US Pat. 7918178

EZ LAUNCH® COMMERCIAL

Launch System for Kayaks with Universal Access

A first in the industry, the EZ Launch® Accessible Transfer System for kayaks and canoes provides individuals with disabilities accessibility that exceeds the minimum requirements of the Americans with Disabilities Act (ADA). The easy-to-use transfer bench and transfer slide boards allow users to simply sit, slide over, and drop down into a kayak or canoe then use the side rails to pull off or back on.

EZ Launch Commercial Features

- Guide rails for easy access in and out of the water
- Launch rollers for easy movement of the watercraft
- Floating platform that adjusts to changing water levels

EZ Launch Universal Access Features

- Transfer bench with two heights for easy transfer from wheelchair
- Transfer slide board with two heights for differing watercraft sizes
- Railing system for slide board stabilization & support for easy movement

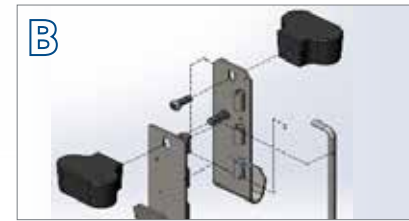
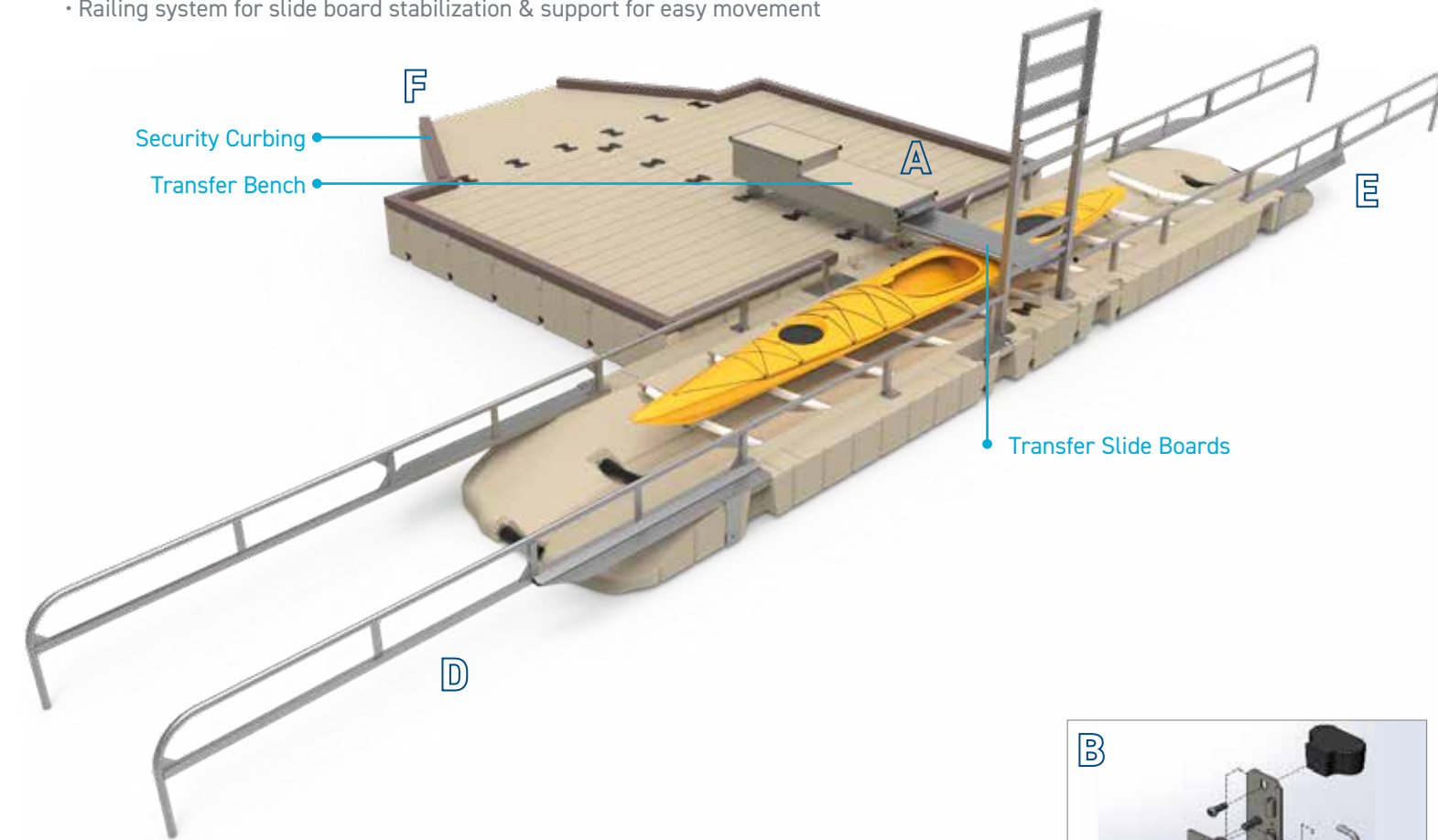
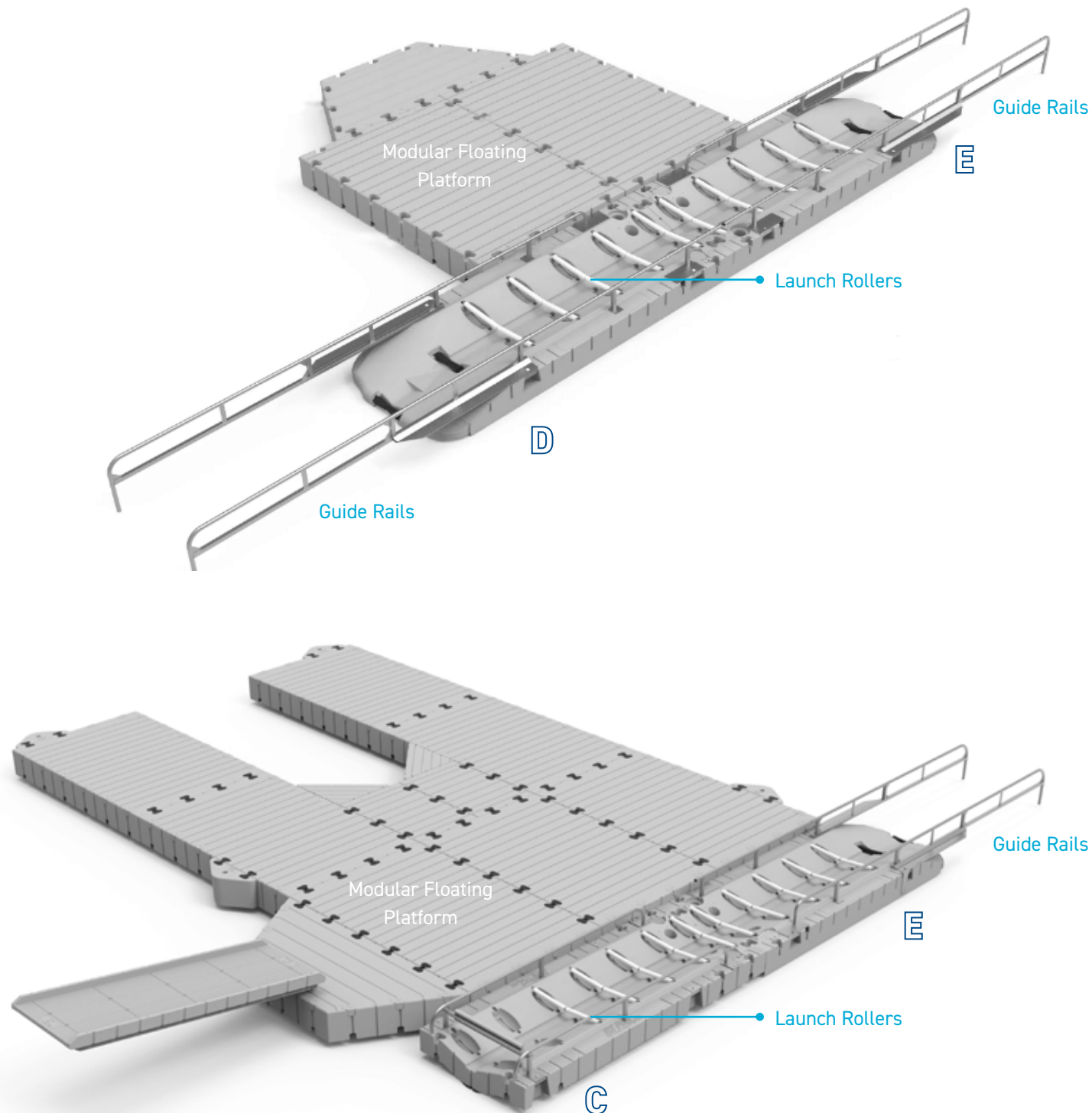

	Part #	Model	Weight
A	5008900	EZ Launch Transfer System	350 lbs.
B	100757SS	EZ Launch Adjustable Adapter Kit	23 lbs.
C	500901	EZ Launch Extension Railing	126 lbs.
D	500900L	EZ Launch Entry Railing Left	126 lbs.
E	500900R	EZ Launch Entry Railing Right	126 lbs.
F	35116	Security Curbing	
Not Shown	S50911	PVC Sleeved Roller	

Boat Entry Assistance System | Pat. 9708038

EZ LAUNCH® COMMERCIAL CUSTOMIZED SOLUTIONS

EZ Launch® Drive Thru with Transfer Bench & Small Platform

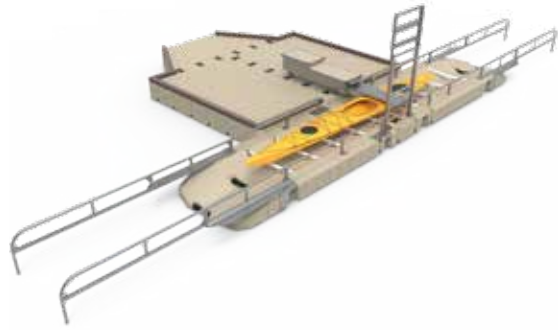

EZ Launch® Multiple One-way with Transfer Bench

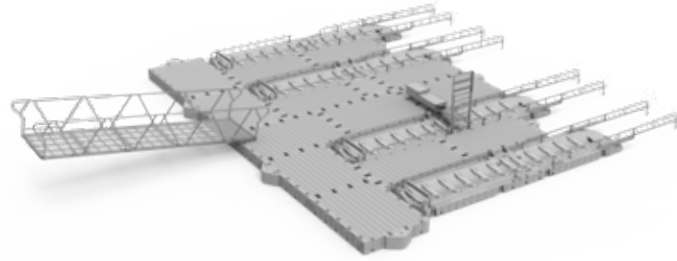

EZ Launch® One-way with Large Platform & Boat Slip

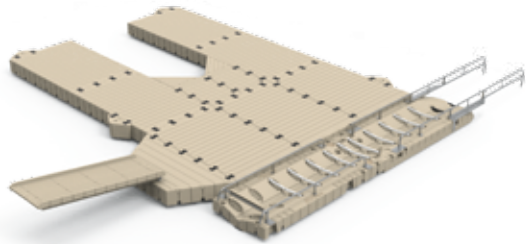

EZ Launch® One-way & Extra-Large Platform

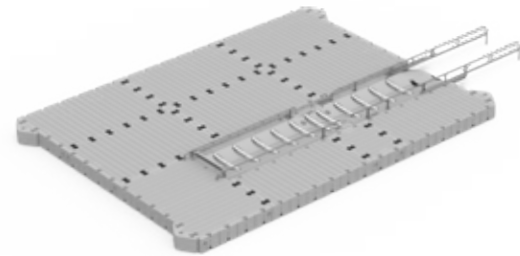

EZ Launch® One-Way with Transfer Bench, Handrail, & Large Platform

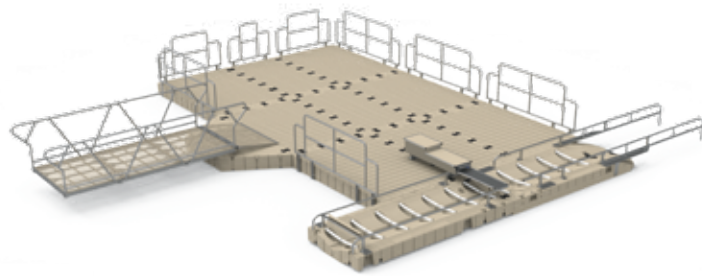

EZ Launch® Drive Thru with Large Platform

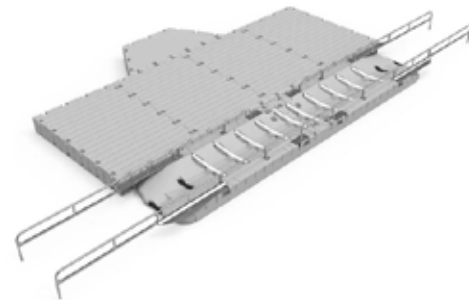

EZ Launch® One-Way with Small Platform & Tri Dock

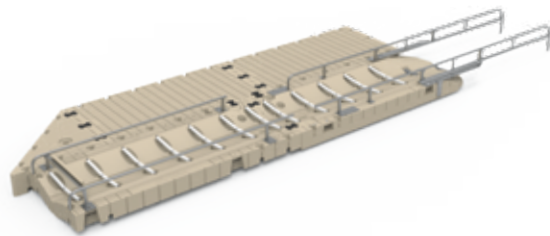

EZ Launch® Drive Thru with Small Platform

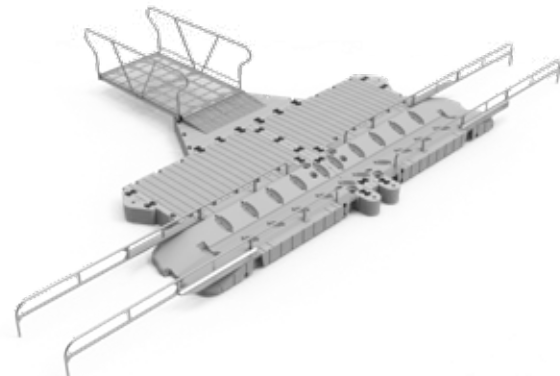

EZ LAUNCH® RESIDENTIAL

EZ Launch Residential Features

- Dock entry enables stable, dry entry.
- Launch-assist paddle notches support easy entry/exit. V-shaped entry centers vessel for a confident, consistent launch.
- Engineered to connect with virtually any dock (EZ Dock or any other dock).
- Fits canoes, tandem kayaks, stand-up paddleboards, etc.

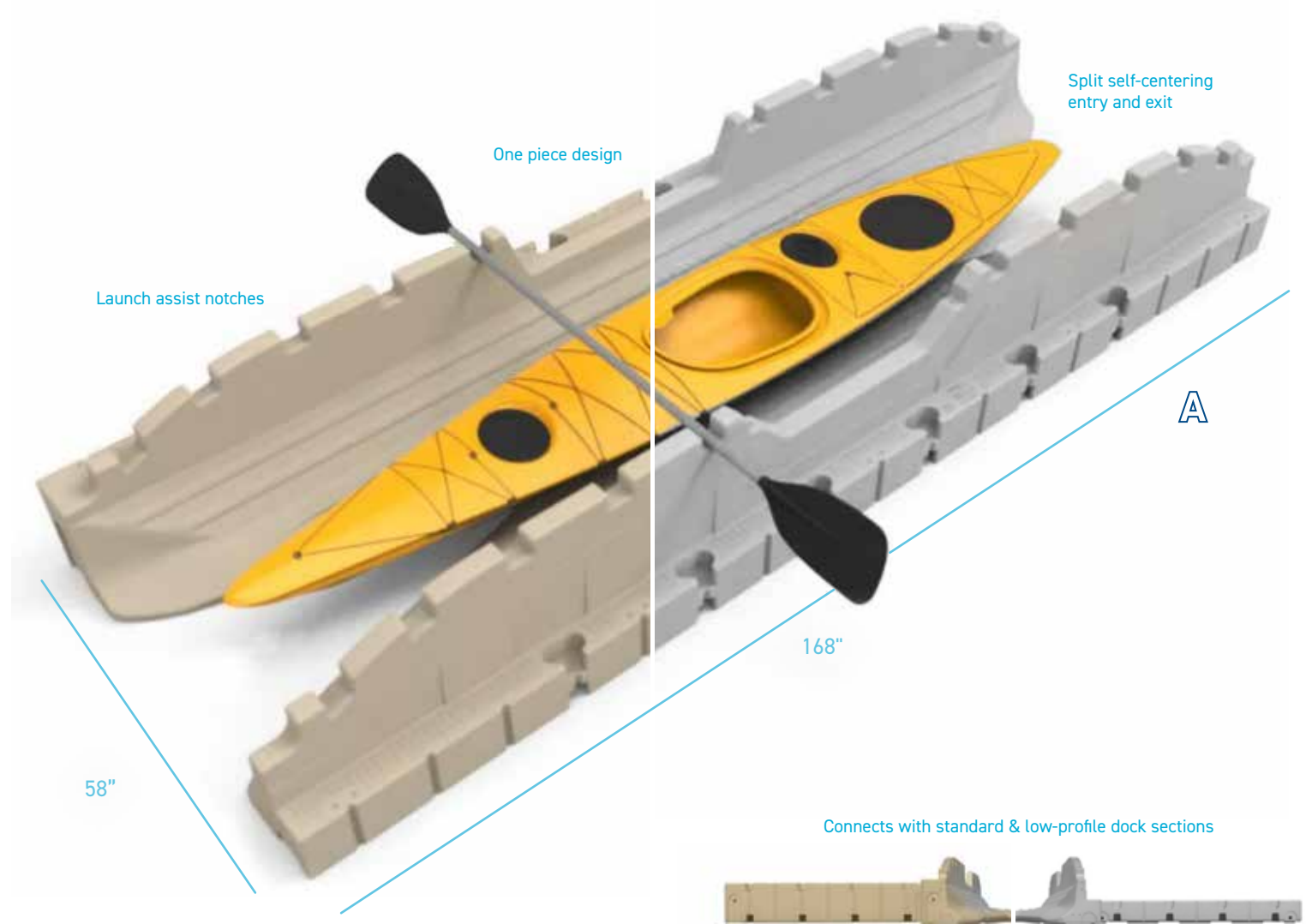

Part #	Model	Color	Size	Weight	Floatation
200900	EZ Launch for Kayaks	Beige ●	168" x 58" x 24"	400 lbs.	750 lbs.
200900-EZGR		Grey ●			
200683	EZ Launch Extension RAIL	Aluminum ●		N/A	N/A
208112	EZ Launch Slide Bunk Kit	Blue ●		N/A	N/A

EZ BOATPORT®

The EZ BoatPort is a simple and stable drive-on, drive-off method of docking for boats in a wide range of sizes up to 4,000 lbs.

EZ BoatPort Features

- Configurations to fit multiple boat shapes and sizes
- Works with existing floating or fixed docks
- Can be used in as little as 2ft of water without float tanks
- No winching, cranking, or hoisting
- Two skid bunk options to fit a variety of hull shapes and sizes
- Up to three additional keel rollers for longer boats
- Optional supplemental flotation kit for added buoyancy
- Optional side extensions for additional walk-around room

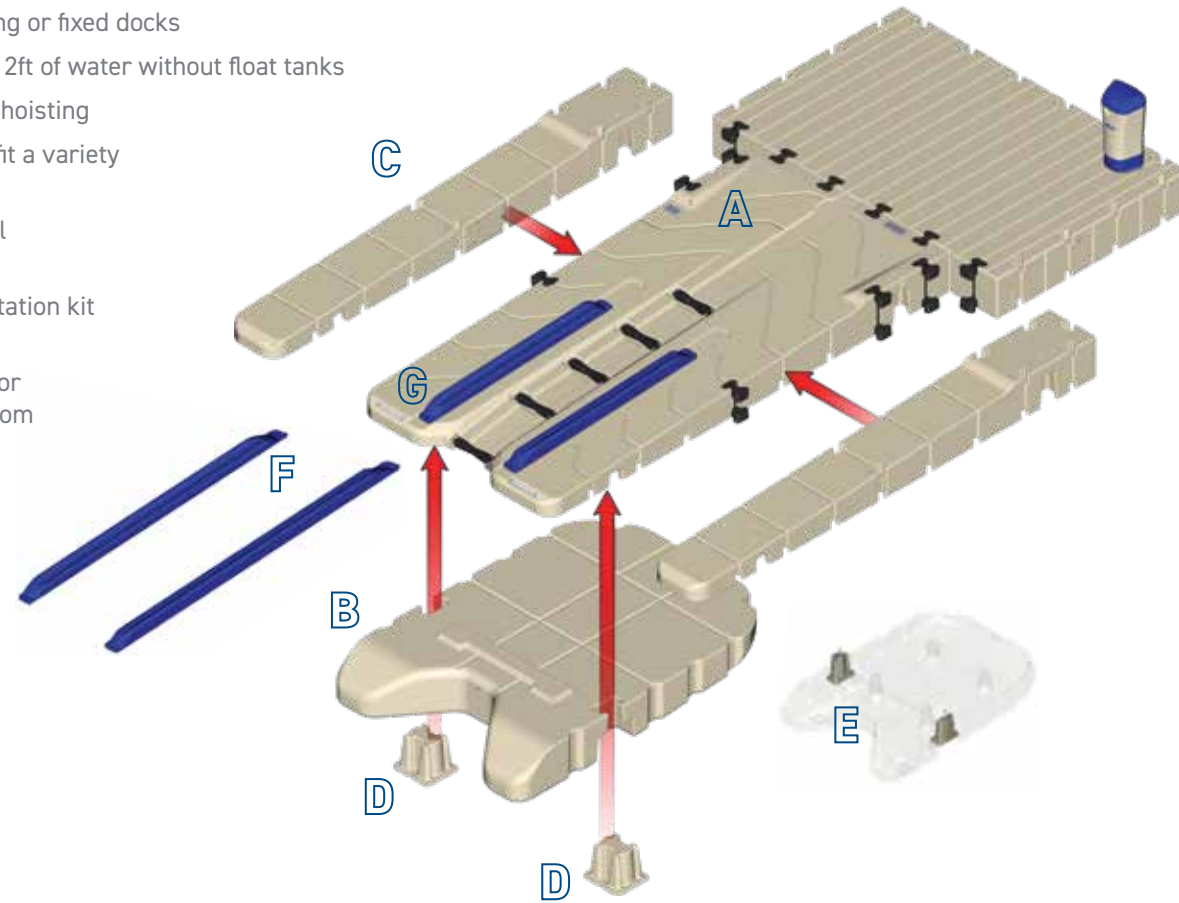

Part #	Model	Color	Size	Weight	Floatation
A	208015BL	Beige ●	164" x 78" x 14-5/8"	500 lbs.	2000 lbs.
	208015BL-EZGR	Grey ●			
B	208015FT	Beige ●	111" x 78" x 19.625"	240 lbs.	2000 lbs.
	208015FT-EZGR	Grey ●			
C	208015EX	Beige ●	164" x 20" x 14.625"	140 lbs.	500 lbs.
	208015EX-EZGR	Grey ●			
D	208104	Beige ●	13.5" x 7.5" x 12"	15 lbs.	N/A
	208104-EZGR	Grey ●			
E	208105	Beige ●	13.5" x 7.5" x 12"	7 lbs.	N/A
	208105-EZGR	Grey ●			
F	208101	Blue ●	108" x 8" x 10"	35 lbs.	N/A
G	208102	Blue ●	75" x 8" x 5"	33 lbs.	N/A

EZ BOATPORT® CUSTOMIZED SOLUTIONS

EZ Dock commercial and residential boat ports are a fast and simple solution if you need a low-maintenance, stable, durable, drive-on boat dock.

Long (L) and Short(S) bunk options.

EZ BoatPort with Side Extensions 140 sf
BP3000-EZGR, BP3000

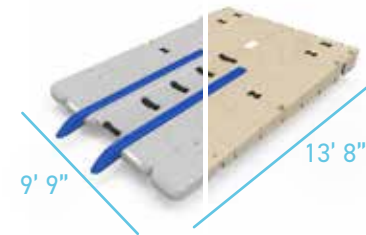

EZ BoatPort with Side Extensions & Large Platform 190 sf
BP3001-EZGR, BP3001

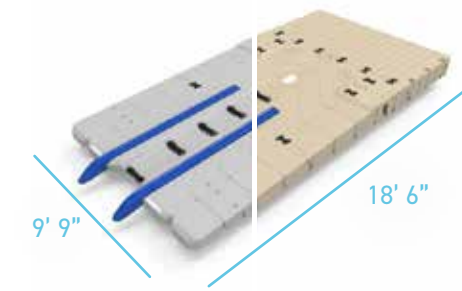

EZ BoatPort with Float Tank & Air Assist 124 sf
BP4000-EZGR, BP4000

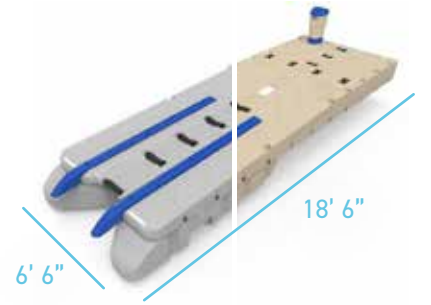

EZ BoatPort with Float Tank, Air Assist, & Large Platform 156 sf
BP4001-EZGR, BP4001

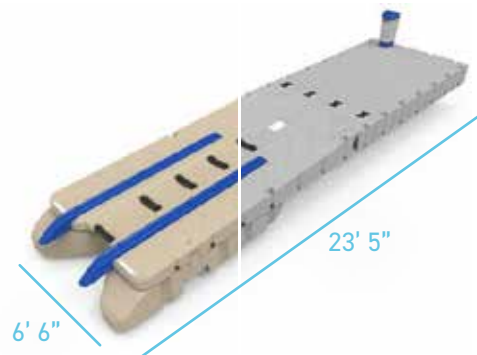

EZ BoatPort with Side Extensions, Float Tank, & Air Assist 205 sf
BP5000-EZGR, BP5000

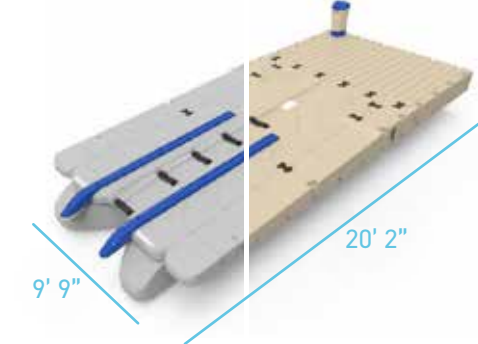

EZ BoatPort with Side Extensions, Float Tank, Air Assist, & Large Platform 240 sf
BP5001-EZGR, BP5001

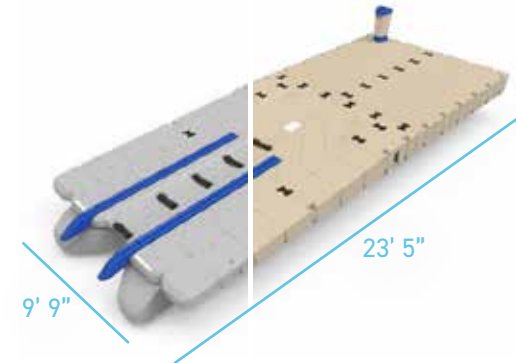

AIR ASSIST PUMPS

Manual, 110VAC, Kit
600053
16" x 14" x 20"
Aluminum
Diamond Plate



Remote, 110VAC, Kit
600052-EZGR, 600052
16" x 14" x 20"
Beige or Grey



Solar Manual 24V
600046-IS
Solar Remote 24V
600048-IS
Box 15" x 13" x 27.5"
Solar Panel
27.5" x 23.75" x 1.25"
Beige or Grey



ANCHORING

Once you've created your EZ Dock, you'll need to select an anchoring system to work with your existing piling or your new installation. Our wide variety of anchoring components can accommodate most water conditions and bottoms (deep, shallow, rough, muddy, or sandy) and are simple to install. EZ Dock anchoring products are made from long-lasting, durable materials that can accommodate standard or heavy-duty use. Your local dealer can help you select the anchoring system that's right for your location. Call us at 1-800-654-8168.



STANDARD PIPE BRACKET
Standard-duty polyethylene bracket provides ample anchoring for ports and smaller docks.



HEAVY-DUTY PIPE BRACKET
Heavy-duty polyethylene pipe bracket allows docks to adjust to changing water levels.



HEAVY DUTY PIPE BRACKET W/ INSERT
Heavy-duty polyethylene pipe bracket allows docks to adjust to changing water levels.



STIFF-ARM BRACKET
Includes hardware. Order stiff-arm insert, post sleeve, and anchoring pipe separately.



STIFF-ARM HEAVY DUTY BRACKET
Anchor to a shoreline abutment or to a shoreline post. Light-duty also available.



POLY PIPE STAND-OFF BRACKET
Bracket attaches top of pipe to stationary docks. Fits pipe from 2.5" to 3.5" O.D.



ADJUSTABLE PILING BRACKET
Heavy-duty one-piece bracket allows lateral position adjustment to attach to piles from 6"-18" in diameter. Bracket comes with two pairs of couplers with composite hardware.



PILING BRACKET AND HOOPS
Predrilled for hoops (sold separately) and includes nuts and connectors. SS hardware available.



DEADWEIGHT BRACKET
For light-duty anchoring with chain and/or to attach 4" (10cm) x 4" (10cm) railing or mooring posts. Sold in pairs. Chain sold separately.



DEADWEIGHT SLEEVE INSERT
Deadweight insert anchors heavy-duty PE pipe bracket to docks in deep water or rocky bottoms.



DEADWEIGHT WINCH INSERT
Deadweight insert and cable winch added to our polyethylene pipe bracket allows easy dock adjustment for water fluctuations. Cable sold separately.



ADAPTOR HINGE
Reversible hinge allows EZ Port PWC lifts or EZ Dock sections to be attached to other floating docks.



PIPE AUGERS
Auger with bolt and nut allows for drilling and setting pipe in lake, river, or ocean bottoms. Pipe sold separately.

Part #	Model	Size		
A	135250(-EZGR)	For 2.375" (6cm) O.D. Pipe		
	135350(-EZGR)	For 3.5" (9cm) O.D. pipe		
B	215250(-EZGR)	For 2.375" (6cm) O.D. pipe		
	215350(-EZGR)	For 3.5" (9cm) O.D. pipe		
C	210250(-EZGR)	For 2.375" (6cm) O.D. Pipe		
	210350(-EZGR)	For 3.5" (9cm) O.D. pipe		
D	100700	Mainframe Bracket		
	800095-15	I.D. post sleeve for stiff arm	2" post sleeve	
E	800099	Stiff-Arm Heavy Duty Bracket	Frame & Yoke (shown)	
	S80094		Sea wall attachment bracket (not shown)	
F	1051000	Poly Pipe Stand-Off Bracket	Frame & Yoke (as shown)	
G	300810(-EZGR)	Adjustable Piling Bracket (NEW)	75" x 8" x 5"	
H	100800	Piling Bracket (for hoops below)		
	100804	Hoop for Piling Bracket	4" Hoop	
	100806	Hoop for Piling Bracket	6" Hoop	
	100808	Hoop for Piling Bracket	8" Hoop	
	100812	Hoop for Piling Bracket	12" Hoop	
	100816	Hoop for Piling Bracket	16" Hoop	
	100820	Hoop for Piling Bracket	20" Hoop	
	100824	Hoop for Piling Bracket	24" Hoop	
	I	100740	Deadweight Bracket Kit	
		100740SS	Deadweight Bracket Kit Stainless	
J	215350	Bracket & Insert for 3.5" O.D. pipe		
	100725P	Deadweight insert for #210350 assembly		
K	100730	Deadweight winch insert		
	210350	Heavy Duty Dock Bracket for winch insert		
	100750	Adapter Hinge		
L	100750SS	Adapter Hinge Stainless		
	100751	EZ Port Adapter Hinge		
	100751SS	EZ Port Adapter Hinge Stainless		
M	100255	Pipe Auger	For 2.375" OD Pipe	
	100355		For 3.5" OD Pipe	

ACCESSORIES

With the EZ Dock modular system, you can add a wide variety of accessories including storage boxes, bumpers, cleats, benches, ladders, and slides using our easy-to-use coupling system. Do you have a specialty item or piece of equipment that you want affixed to your dock? Simply use our hardware connectors to bolt it directly to the section you choose. It's that easy.



CORNER STORAGE BOX

This roomy storage box's compact design makes the most of available space without interfering with foot traffic. Also available in connection boxes for complete utility hookups.



STORAGE BOX

Permanently mounted and constructed of weather-resistant materials, the EZ Dock Storage Box is a great place to store life jackets, towels, and other essential supplies.



CORNER GUSSET

Polyethylene corner gusset adds deck surface and additional stability to dock fingers when needed. 33.5" (85cm) wide, 6" (15cm) high.



TIE-DOWN CLEAT

Tie-down cleat (8") and other accessories attach to heavy-duty stainless-steel T-nuts molded in pairs around dock section perimeters.



TIE-DOWN CLEAT

Tie-down cleat (10") and other accessories attach to heavy-duty stainless-steel T-nuts molded in pairs around dock section perimeters.



UTILITY CHANNEL

Two-piece chaseway attaches to dock sections for utility lines. Stainless steel hardware option.



SWIM LADDER

One-piece polyethylene ladder is designed for maximum safety with no exposed hardware and 400 pounds of weight capacity. Slip-resistant, textured surface stays cool in hot weather.



DOCK BUMPER

This dock bumper is designed to protect the boat gunwales and rub-rails. Dock bumper will attach to dock using embedded T-nuts.



POLY BENCH WITH ARM-RESTS

Redesigned brackets with 2" round, .25" aluminum tubing. Installs along any open 3-pocket span on an EZ Dock product.



DOCK SLIDE

Utilizes rugged polyvinyl-coated steps, and a one-piece polyethylene bedway for a smooth ride. Install with almost any EZ Dock* where water depth is more than 5'. (Requires use of (2) 80" dock sections.)



SUPPLEMENTAL FLOTATION POD

This float pod is designed to add 200lbs (91 kg) of flotation and is sized to fit under most dock pylon shapes.



DOCK WHEELS

Steel frames with polyethylene wheels make movement of docks easier. Sold in pairs.



POLY BENCH WITHOUT ARM-RESTS

Redesigned brackets with 2" round, .25" aluminum tubing. Installs along any open 3-pocket span on an EZ Dock product.



IN-WATER INSTALLATION TOOL

In-water connection tool for dock sections.



SOCKET ADAPTER TOOL

Socket tool for connection hardware.



HARDWARE CONNECTORS (M/F)

For attaching various accessories. .625" SS bolts and nuts.

	Part #	Model	Color
A	300760	Corner Storage Box w/Gusset	Beige ●
	300760-EZGR		Grey ●
B	300750	Storage Box	Beige ●
	300750-EZGR		Grey ●
C	300501	Corner Gusset	Beige ●
	300501-EZGR		Grey ●
D	300260	Swim Ladder	Beige ●
	300260-EZGR		Grey ●
E	300180	Dock Bumper	Beige ●
	300180-EZGR		Grey ●
F	300970AL	Poly Bench with Arm-rests	Beige ●
	300970AL-EZGR		Grey ●
G	300965AL	Poly Bench without Arm-rests	Beige ●
	300965AL-EZGR		Grey ●
H	9000010ss	In-Water Installation Tool	Stainless Steel ●
I			

	Part #	Model	Color
I	300100	8" Tie-down Cleat	Black ●
J	300110	10" Tie-down Cleat	Aluminum ●
	302060		Beige ●
K	302060-EZGR	5' x 20" Utility Channel	Grey ●
	302020		Beige ●
L	302020-EZGR	20' x 20" Utility Channel	Grey ●
	302030		Beige ●
M	302030-EZGR	20" Inside Corner	Grey ●
	302040		Beige ●
N	302040-EZGR	20" Outside Corner	Grey ●
	300600		Blue ●
O	300600FG	Dock Slide	Forest Green ●
	208110		Beige ●
P	208110-EZGR	Supplemental Flotation Pod	Grey ●
	900050		Black ●
Q	201040SS	Hardware Connector Male	Black ●
	201041SS	Hardware Connector Female	Black ●

RAILING

Aluminum 42" (1.1m) high guardrails meet SOBA and ADA guidelines and are designed to provide security with minimal obstruction. Choose the standard aluminum finish or optional powder-coated finish—available in sand, royal blue, brown, forest green (shown below). Hardware included.

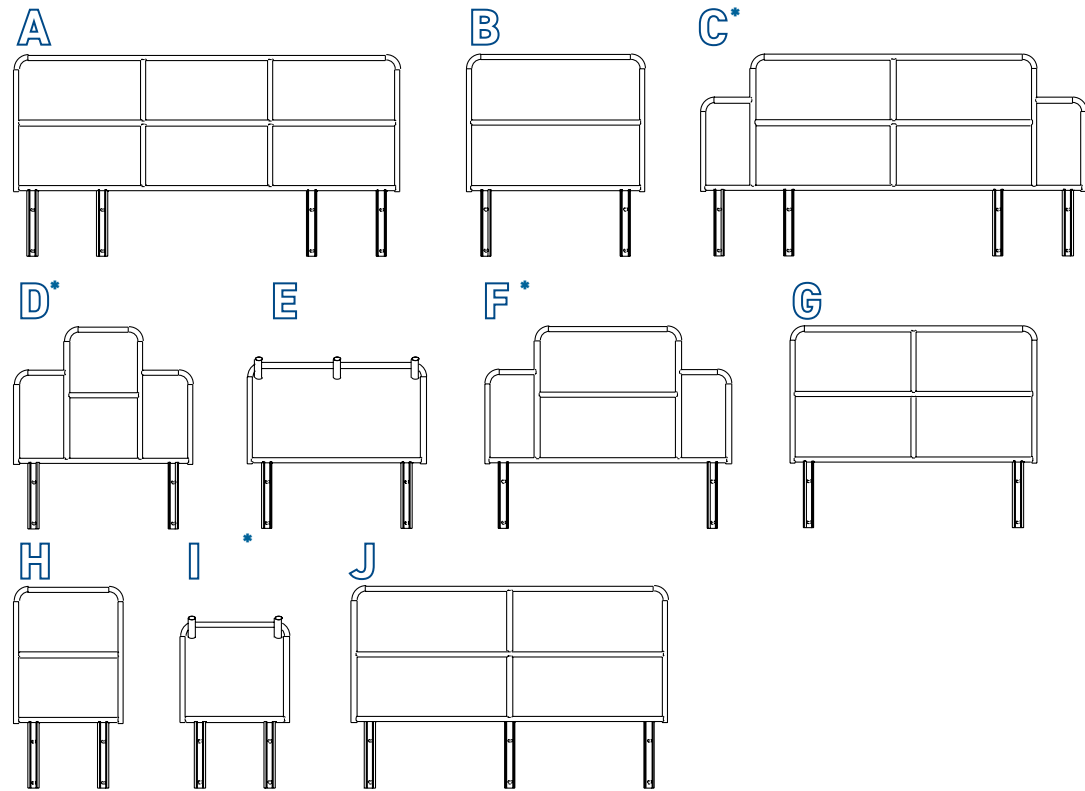

- FRG - Forest Green
- DBW - Brown
- BLU - Blue
- BEI - Beige
- AL - Aluminum, standard



POLY POST HANDRAILS
Attaches to the coupler pocket. Can be used as a grab or accessory attachment post. 8 embedded T-nuts for cleat attachment and recessed holes that can be drilled for tube or rope handrails. (Handrails and Cleats not included.)

	Part #	Model	Color	Size
A	100910AL	Style 910	Aluminum <input type="radio"/>	10' (3m) Width
	105910		Alum. Powder Coat <input type="radio"/>	
B	100911AL	Style 911	Aluminum <input type="radio"/>	5' (1.5m) Width
	105911		Alum. Powder Coat <input type="radio"/>	
C	100912AL	Style 912	Aluminum <input type="radio"/>	10' (3m) Width
	105912		Alum. Powder Coat <input type="radio"/>	
D	100915AL	Style 915	Aluminum <input type="radio"/>	5' (1.5m) Width
	105915		Alum. Powder Coat <input type="radio"/>	
E	100916AL	Style 916	Aluminum <input type="radio"/>	5' (1.5m) Width
	105916		Alum. Powder Coat <input type="radio"/>	
F	100917AL	Style 917	Aluminum <input type="radio"/>	80" (2m) Width
	105917		Alum. Powder Coat <input type="radio"/>	
G	100918AL	Style 918	Aluminum <input type="radio"/>	80" (2m) Width
	105919		Alum. Powder Coat <input type="radio"/>	
H	100919AL	Style 919	Aluminum <input type="radio"/>	40" (1m) Width
	105919		Alum. Powder Coat <input type="radio"/>	
I	100920AL	Style 920	Aluminum <input type="radio"/>	40" (1m) Width
	105920		Alum. Powder Coat <input type="radio"/>	
J	100921AL	Style 921	Aluminum <input type="radio"/>	100" (2.5m) Width
	105921		Alum. Powder Coat <input type="radio"/>	
K	100900	Poly Post Handrails	Beige <input type="radio"/>	
	100900-EZGR		Grey <input type="radio"/>	

BOAT LIFT 7

EZ Dock's newest entry in the boat lift category is the Aegis™ 7 Boat Lift. This boat lift promotes fast and convenient access to your boat and keeps it looking like new. EZ Dock offers a complete system including new air-assist pumps in both 110 volt (standard) and solar models (optional). Each boat lift is available with manual control (standard) placed near the lift or with remote control (optional). The Aegis boat lift tank system is precision-molded with linear low-density polyethylene (LLDPE), resistant to the worst weather conditions, and low water damage. The lift keeps the boat out of the water and free from marine growth on outdrives and the hull of your boat. The frame is constructed from hot-dipped, galvanized steel and corrosion-resistant hardware. The lift also allows you to have easy access to your watercraft to eliminate difficult maintenance challenges. The lift is compatible with EZ Dock products and traditional dock systems. Through the use of our air assist pumps, the new boat lift is capable of hoisting boats up to 7,000 lbs. in weight and 28 feet in length. The Aegis 7 Boat Lift features fully adjustable standard bunk locations for V hull boats, with the ability to customize as needed for a variety of hull configurations. The lift also features premium low-friction and high strength, ultra-high molecular weight (UHMW), polyethylene bearing surfaces.

Part #	Model
BL7000	Aegis 7 Boat Lift - VHULL
BL7000PT	Aegis 7 Boat Lift - PONTOON
BL7000TT	Aegis 7 Boat Lift - TRITOON
BL7000WB	Aegis 7 Boat Lift - WAKE BOAT



Dimensions 10'-12' Wide x 13' 8" Long

Lift Capacity Up to 7000 lbs.

Weight ~1000 lbs

of Tanks 2

Slip Wicth 10'-12'

Minimum Water Depth 5'

Boat Length Capacity Up to 28'

Tank Color Blue



GANGWAYS ALUMINUM

EZ Dock's aluminum gangways are well suited for residential or commercial applications in both fresh and salt water. The gangways are made from corrosion resistant 6000 series aluminum and are not only strong, but they are low maintenance and can be easily cleaned. No painting or staining is required to keep them looking great for years to come. Constructed in accordance with the minimum provisions of States Organizations for Boating Access (SOBA), standard EZ Dock aluminum gangways also meet ADA guidelines. The gangways offer continuous handrails extending 12 inches past the walking surface on both ends, and kick plates are standard features. Aluminum gangways support 90 pounds per linear foot and a concentrated load of 400 pounds applied to any 12" X 12" area. This latest version of the aluminum gangways is more rigid and yet adapts to all types of weather conditions. They include detachable handrails, making the shipping, handling, and assembly significantly less labor intensive. The slip resistant decking used is specifically made for marine applications. It has a mill-finish and knurl pattern to provide better footing. The gangways come in 3' and 5' widths, with length options from 8' to 32'. The gangways are compatible with all existing EZ Dock shore mounts, rollers, and transition plates.

Stability Cool, slip-resistant surface provides maximum stability and support as you walk to your dock or launch

Durability Capacity of 400 lbs. per square foot, with welded aluminum walkway structure

Customization Can be customized with components designed to make it easier to link the shore, gangway, and dock together



Aluminum Gangways - 3' Wide, Aluminum Decking, Detachable Aluminum Railing and Hardware

Part #	Model - Product Description	Length	Width (Inside)	Width (Outside)	Weight
G400308	Gangway at 3' x 8' w/hardware, railings, AL deck	8'	36"	41"	202
G400312	Gangway at 3' x 12' w/hardware, railings, AL deck	12'	36"	41"	281
G400316	Gangway at 3' x 16' w/hardware, railings, AL deck	16'	36"	41"	372
G400320	Gangway at 3' x 20' w/hardware, railings, AL deck	20'	36"	41"	449
G400324	Gangway at 3' x 24' w/hardware, railings, AL deck	24'	36"	41"	524
G400328	Gangway at 3' x 28' w/hardware, railings, AL deck	28'	36"	41"	618
G400332	Gangway at 3' x 32' w/hardware, railings, AL deck	32'	36"	41"	688

Aluminum Gangways - 5' Wide, Aluminum Decking, Detachable Aluminum Railing and Hardware

G400508	Gangway at 5' x 8' w/hardware, railings, AL deck	8'	60"	65"	262
G400512	Gangway at 5' x 12' w/hardware, railings, AL deck	12'	60"	65"	365
G400516	Gangway at 5' x 16' w/hardware, railings, AL deck	16'	60"	65"	480
G400520	Gangway at 5' x 20' w/hardware, railings, AL deck	20'	60"	65"	585
G400524	Gangway at 5' x 24' w/hardware, railings, AL deck	24'	60"	65"	687
G400528	Gangway at 5' x 28' w/hardware, railings, AL deck	28'	60"	65"	805
G400532	Gangway at 5' x 32' w/hardware, railings, AL deck	32'	60"	65"	900

GANGWAYS POLYETHYLENE

Engineered with the same technology and quality as our dock sections, EZ Dock gangways offer uncompromised durability and modular versatility. Gangways are manufactured from aluminum or polyethylene.

Molded Plastic Gangway
US Pat. 6912966



Gangway 404010
10' section polyethylene gangway.
(Railing and Roller Kit are sold separately.)



GANGWAY ROLLER KIT

300300, 300400, 300450
Gangway Roller Kit allows end of gangway to adjust to changing water levels. PVC and galvanized steel roller available for 3' and 5' widths.



HINGE-TO-FLOAT

G200360, G200560
400410, 400460, 400480
Hinged bracket with hardware attaches gangway to dock.



GALVANIZED GANGWAY TO DOCK KIT

400460, 400480
Kit will include all hardware to attach gangway centered on 3 or 4 pockets.



TRANSITION KIT

100717 (15") or 100718 (30")
Hinged polyethylene plate creates a smooth transition between EZ Dock or EZ Port and another floating dock.



GANGPLANK MOUNTING KIT

100240, 100340 or 100600
Galvanized steel hinge bracket and hardware for wood walkways 24", 34", or 60" wide. Lumber not included.

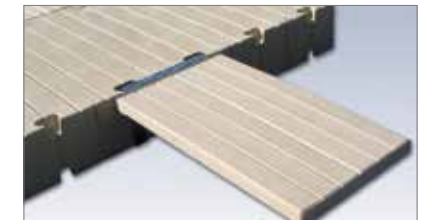

PLANK GANGWAY

200200
Hinged polyethylene panel creates a smooth transition between shore grade and deck surface.



Proudly American made for 30 years.



The EZ Dock global network of highly trained and knowledgeable dealers and distributors is ready to help. Our experienced team is standing by to help you choose a system that will maximize your space and suit your specific application.

Visit our website at ez-dock.com to create your perfect dock or to find your local EZ Dock dealer.

US/Canada	1-800-654-8168
Europe	+46 (0) 380 47 300
International	+1-417-235-2223

EZ Dock product is produced in our Monett, MO facility which is certified by Intertek for ISO 9001:2015 quality management system and ISO 14001: 2015 environmental management system.

EZ Dock may introduce new colors, products, accessories, and options throughout the year. Specifications and products listed are subject to change without notice. Some products may be shown with additional or optional equipment not available through EZ Dock. Specifications may vary for international shipments. Please check with your local dealer for more information. EZ Dock is a product of the U.S.A.

EZ Dock, Inc | 878 HWY 60, Monett, MO 65708 | 417-235-2223 | 800-654-8168

© 2022 EZ Dock, Inc. All rights reserved.